



YDLIDAR TG50 DATASHEET

DOC#: 01.13.005400

Contents

Overview.....	2
Product Features.....	2
Applications.....	2
Installation and Dimensions.....	3
Specifications.....	3
Product Parameter.....	3
Electrical Parameter.....	4
Interface Definition.....	4
Data Communication.....	5
Motor Control.....	6
Optical Characteristic.....	6
Polar Coordinate System Definition.....	6
Others.....	7
Development and Support.....	7

OVERVIEW

YDLIDAR TG50 is a 360-degree two-dimensional rangefinder (hereinafter referred to as TG50) developed by YDLIDAR team. Based on the principle of TOF, it is equipped with related optics, electricity, and algorithm design to achieve high-frequency and high-precision distance measurement. The mechanical structure rotates 360 degrees to continuously output the angle information as well as the point cloud data of the scanning environment while ranging.

Product Features

- 360 degree omnidirectional scanning ranging distance measurement
- Small distance error, stable performance and high accuracy
- IP65 protection level
- Strong resistance to ambient light interference
- Industrial grade brush-less motor drive for stable performance
- Laser power meets Class I laser safety standards
- 5-12Hz adaptive scanning frequency (support customization)
- Photomagnetic fusion technology to achieve wireless communication, wireless power supply
- Ranging frequency up to 20kHz (support customization)

Applications

- Robot navigation and obstacle avoidance
- Industrial automation
- Robot ROS teaching and research
- Regional security
- Smart transportation
- Environmental scanning and 3D reconstruction
- Commercial robot /Robot vacuum cleaner

Installation and dimensions

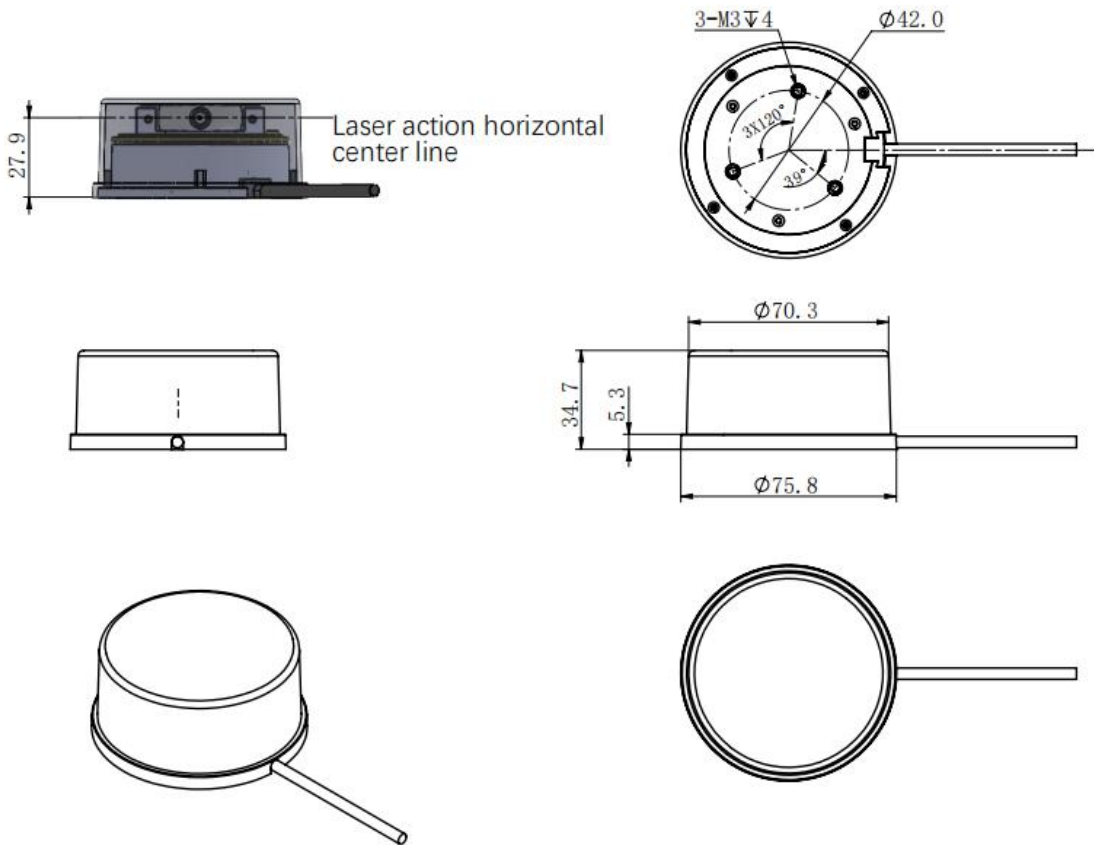

FIG1 YDLIDAR TG50 INSTALLATION&MECHANICAL SIZE

SPECIFICATIONS

Product Parameter

CHART1 YDLIDAR TG50 PRODUCT PARAMETER

Item	Min	Typical	Max	Unit	Remarks
Ranging frequency	-	20000	-	Hz	
Motor frequency	5	7	12	Hz	Software control, factory setting 7HZ
Ranging distance	0.05	-	50	m	80% reflectivity
Scanning angle	-	0~360	-	Deg	-
Ranging resolution		\pm 4		cm	
Angle resolution	0.09 (Motor Frequency at 5HZ)	0.13 (Motor Frequency at 7HZ)	0.22 (Motor Frequency at 12HZ)	Deg	Ranging frequency=20k

Electrical Parameter

CHART2 YDLIDAR TG50 ELECTRICAL PARAMETER

Item	Min	Typical	Max	Unit	Remarks
Supply voltage	4.8	5.0	5.2	V	Excessive voltage might damage the Lidar while low affect normal performance
Voltage ripple	-	-	100	mV	Excessive ripple affect normal performance
Sleeping current	-	-	50	mA	System sleep, motor stops
Working current	400	450	480	mA	System work, motor rotation

Note: it is recommend to use 5V 1A power supply device or circuit design.

Interface Definition

TG50 provides PH2.0-5P female connector to realize system power and data communication function.

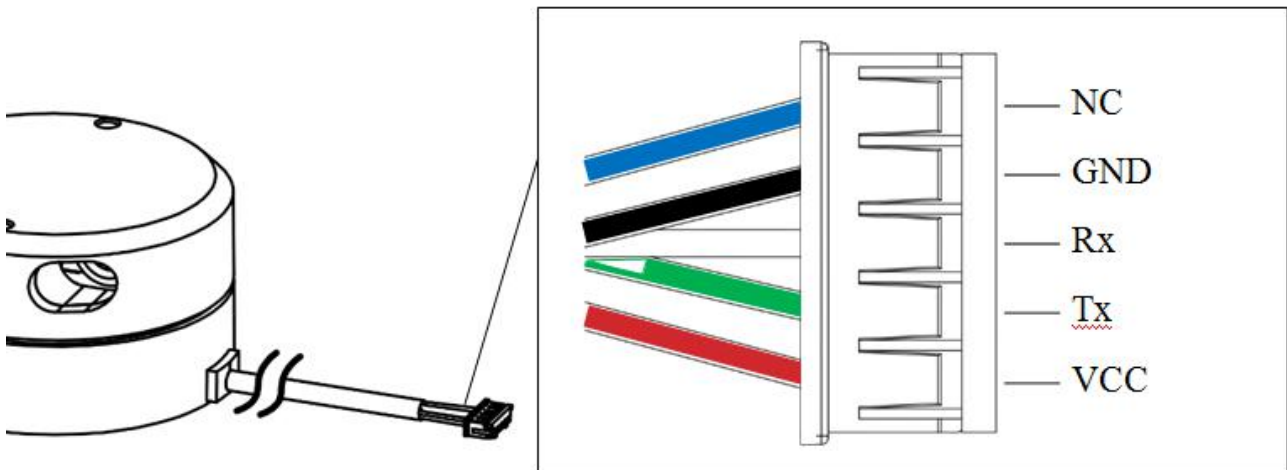

FIG2 YDLIDAR TG50 INTERFACES

CHART3 YDLIDAR TG50 INTERFACE DEFINITION

Pin	Type	Description	Defaults	Range	Remarks
VCC	Power Supply	Positive	5V	4.8V~5.2V	-
Tx	Output	System serial output	-	-	Data stream: Lidar → Peripherals
Rx	Input	System serial port Input	-	-	Data stream: Peripherals → Lidar
GND	Power Supply	Negative	0V	0V	-
NC	-	Reserved pin	-	-	-

Together with lidar, it has a PH2.0-5P to USB adapter board.

Type-C USB: data communication and power supply.

Micro USB: power supply.

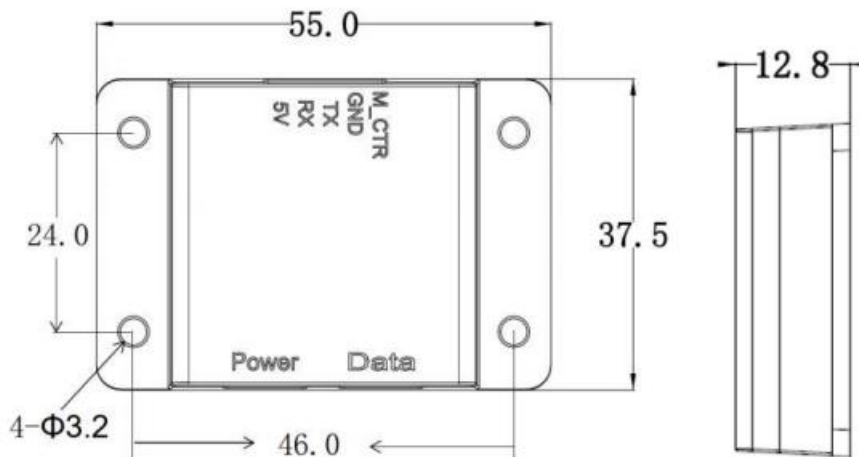
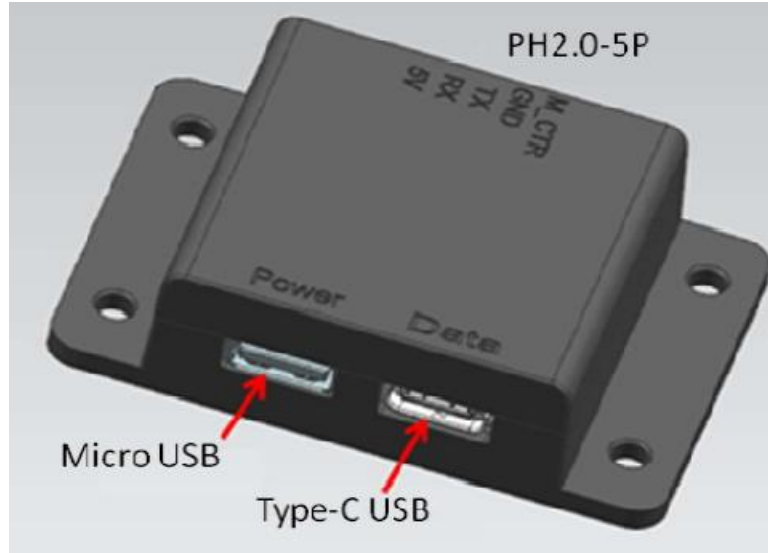

FIG3 YDLIDAR TG50 Polar coordinate system definition

Data communication

With a 3.3V level serial port (UART), users can connect the external system and the product through the physical interface. After that, you can obtain the real-time scanned point cloud data, device information as well as device status. The communication protocol of parameters are as follows:

CHART4 YDLIDAR TG50 SERIAL SPECIFICATION

Item	Min	Typical	Max	Unit	Remarks
Baud rate	-	512000	-	bps	8-bit data bit, 1 stop

					bit,no parity
High Signal Level	2.0	-	3.3	V	Signal voltage>2.0V
Low signal Level	0	0	0.8	V	Signal voltage<0.8V

Motor control

The TG50 has its own motor drive with motor speed control function and a command interface instead of a hardware interface for motor control. Please refer to the development manual of this product for details.

Optical Characteristic

TG50 uses an infrared point pulsed laser that meets FDA Class I laser safety standards. The laser and optical lens finish the transmission and reception of the laser signal to achieve high-frequency ranging while working. To ensure system ranging performance, please keep the laser and optical lens clean. The detailed optical parameters are as follows:

CHART5 YDLIDAR TG50 LASER OPTICAL PARAMETERS

Item	Min	Typical	Max	Unit	Remarks
Laser Wavelength	895	905	915	nm	Infrared band
Laser Power	-	15	20	W	Peak power
Laser Power	-	0.8	-	mW	Average power
FDA	 Class I				

Polar coordinate system definition

In order to facilitate secondary development, TG50 internally defines a polar coordinate system.

Pole: the center of the rotating core of the TG50;

Positive direction: clockwise;

Zero angle: The direction of the outlet of the TG50 PH2.0-5P interface cable (top view)

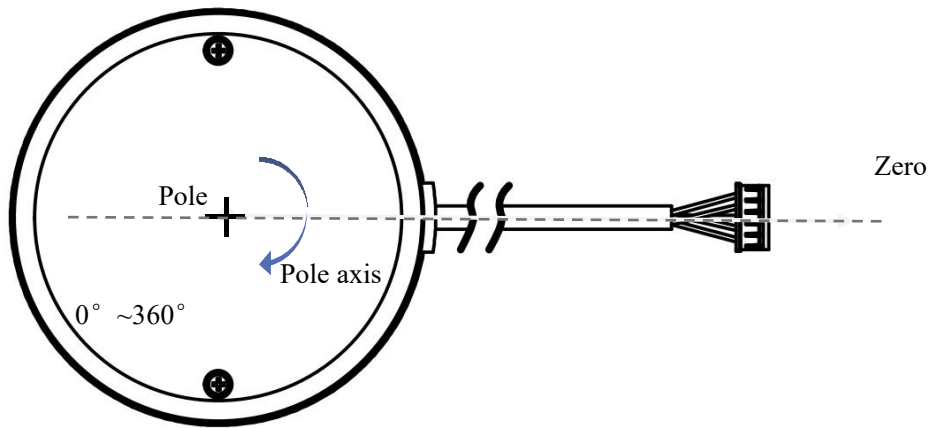

FIG4 YDLIDAR TG50 POLAR COORDINATE SYSTEM DEFINITION

Note: When the Lidar is assembled on the machine, the deviation of the assembly may cause slight difference in the consistency of the zero position. For the convenience of use, we provide a zero calibration software, which can customize the zero direction and assemble to the machine. The Lidar is calibrated twice. For details, please refer to the instruction manual.

Others

CHART6 YDLIDAR TG50 OTHERS

Item	Min	Typical	Max	Unit	Remarks
Operating temperature	0	25	50	°C	Long-term work in high temperature environment will reduce life expectancy
Lighting environment	0	70000	100000	Lux	For reference only
weight	-	140	-	g	N.W.

Development and support

With a wealth of hardware and software interfaces, TG50 can support motor enable control, speed control, and enable control&output control of the ranging core. Thus, users can also implement the power control and scan control purpose.

Also, the 3D model is open. YDLIDAR provides the graphical debugging client-PointCloud Viewers, together with the corresponding SDK development kit and Ros development kit. Users could download from website: <http://www.ydlidar.com>.